

INDUSTRIAL CLEANING AIR PUMP SYSTEMS

BRAUER has developed a range of tooling aids to assist the workshop engineers – whether they are working with metals, plastics or chemicals.

The Brauer Drum Pump is designed to pick up liquid spills in the workshop. The system utilises the standard 205 litre drum including the two holes which are standard in the drum lid. Tests have shown that the Brauer Drum Pump can transfer 125 litres of machine tool coolant in 65 seconds. The Brauer Drum Pump comes with a number of useful tools which allow the transfer of liquids and solids with ease from difficult areas.

The Brauer air pump system CGP22 is designed to convey a wide range of materials both horizontally and vertically over long distances in a ducted system.

When placed in series the air pump will provide enhanced performance by giving improved conveying power over a much greater distance.

SOME TYPICAL APPLICATIONS - DRUM PUMP

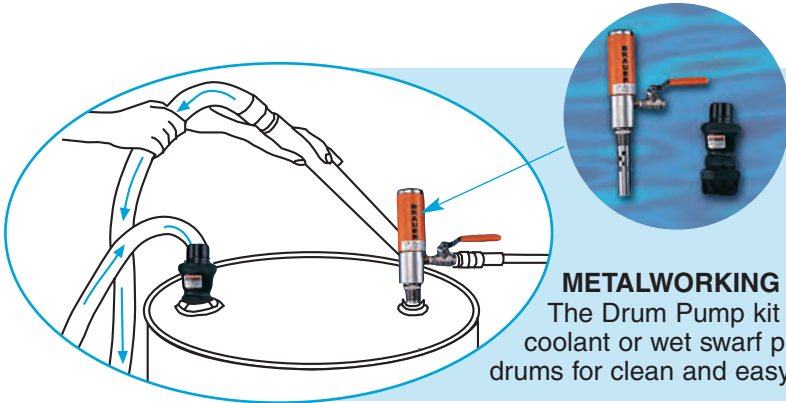

METALWORKING

The Drum Pump kit handles sludge, oil coolant or wet swarf pulling it into drums for clean and easy disposal.

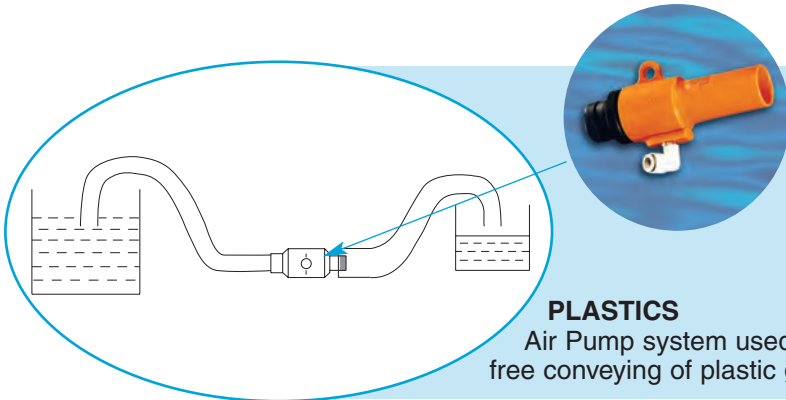

PLASTICS

Air Pump system used for maintenance free conveying of plastic granules.



REMOVING SWARF

Drum pump cleaning up swarf into metal drum for easy disposal.

DP175 LIQUID DRUM PUMP



Material: Pump: Stainless Steel
Connector: Nylon

Weight: 1.6Kg

dB(A) at: 5.5 bar is 92

Standard Inlet Threads: G 1/4

Options: 1" NPT
Please specify on order

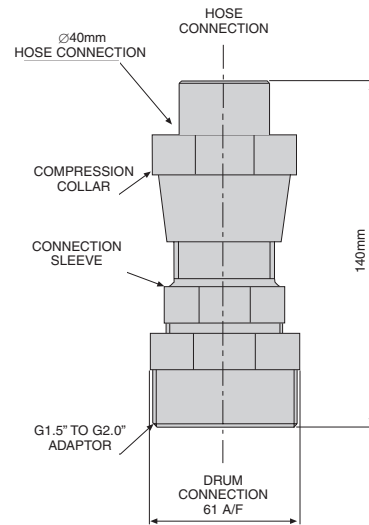
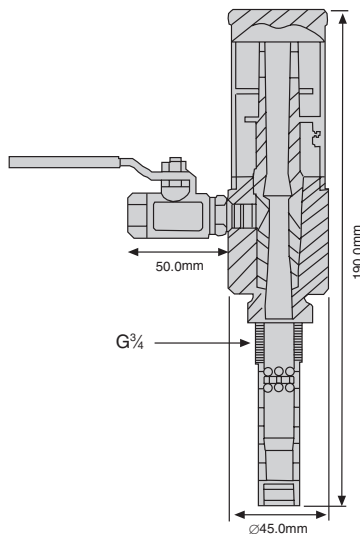

Bar	Vol in m ³ /min	Vol out m ³ /min	SLPM (L/min)
3.93	0.170	0.476	470
4.90	0.212	0.559	560
5.86	0.255	0.641	640
6.90	0.297	0.724	720
7.86	0.340	0.807	810

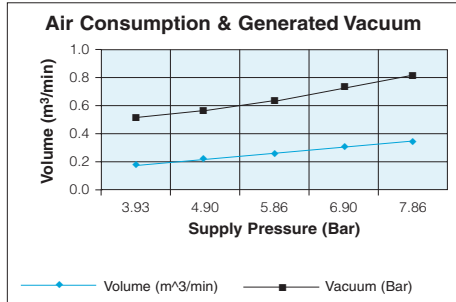

CGP22 AIR PUMP SYSTEM



Material: Nylon.

Weight: 0.12kg

Standard Gap: Adjustable

dB(A) at: 5.5 bar is 79

Standard Inlet Threads: G 1/4

Options: 1" NPT
Please specify on order

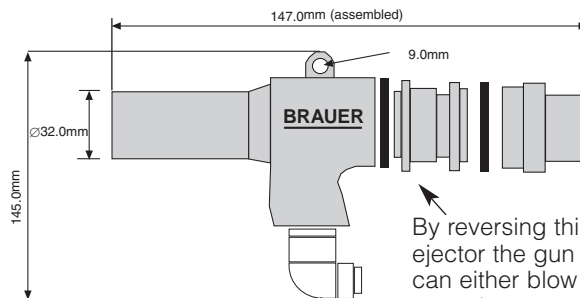

By reversing this gun the ejector the gun can either blow or suck as a vacuum.

Bar	Vol in m ³ /min	Vol out m ³ /min
1.38	0.181	1.512
2.76	0.295	2.352
4.14	0.396	2.856
5.52	0.513	3.360

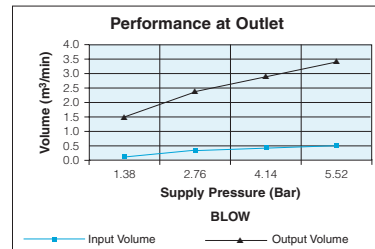

Bar	Vol in m ³ /min	Vol out m ³ /min
1.38	0.185	1.344
2.76	0.304	2.016
4.14	0.421	2.520
5.52	0.531	2.940

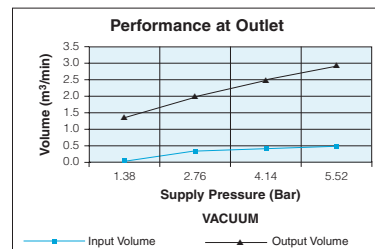

ACCESSORIES FOR DRUM PUMP

A wide range of accessories is available including Extension Tubes, Brushes, and Crevice Tool.

MODEL NO.	DESCRIPTION
DP175-4	HOSE
DP175-5	EXTENSION TUBE
DP175-2	90° QUICK CONNECTOR

